

Residential Pump Fundamentals

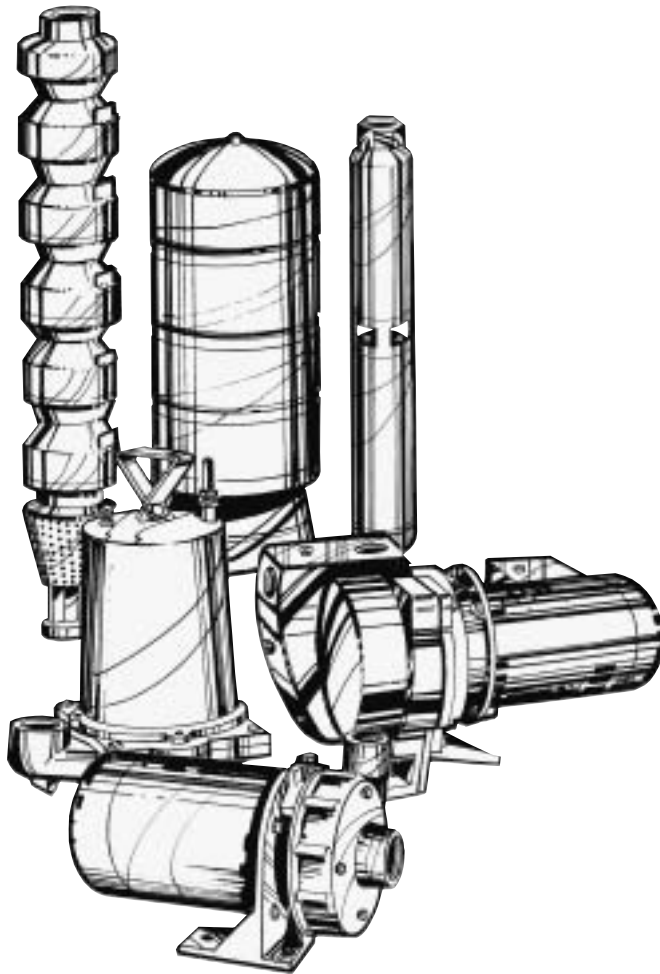

Goulds Pumps and the ITT Engineered Blocks symbol are registered trademarks and tradenames of ITT Industries.

Sources of Water

A source of water or a well is often referred to as shallow or deep. These terms are referring to the depth of the water source or well.

A shallow well is one where the water is within 25 feet of the ground surface.

A deep well is where the static water level is more than 25 feet down.

The standing water level in a well is called the static level. This is the water level when the pump is not operating. When the pump comes on and is running there often is a change in the water level. This is referred to as drawdown. The drawdown occurs and the water level reaches what is referred to as the pumping level. This is the operating level of the pump. The lowest level to which the water will drop is the level from which it must be pumped.

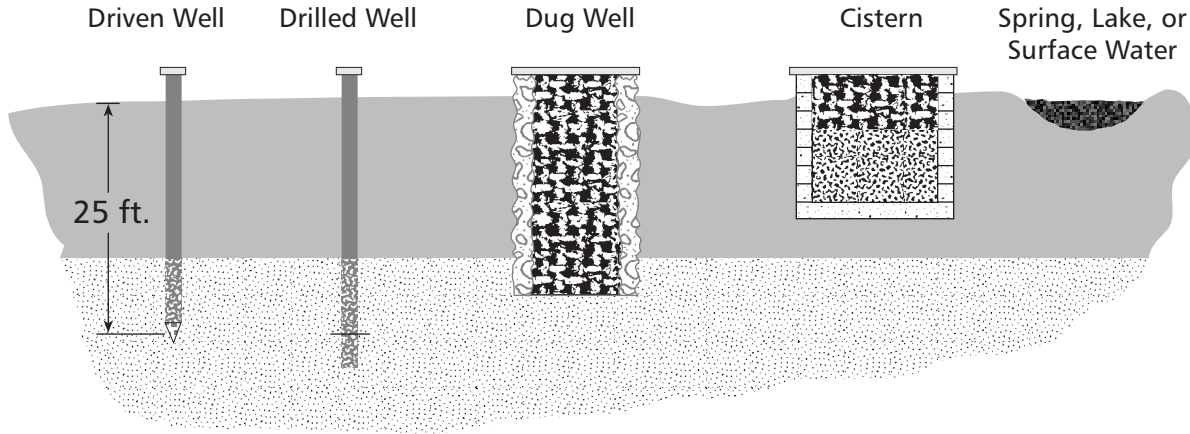

A Shallow Well

Is any source of water where the water is within 25 feet of ground level. When water is pumped from a well the water level will draw down. The lowest level to which it will drop is the level from which it must be pumped.

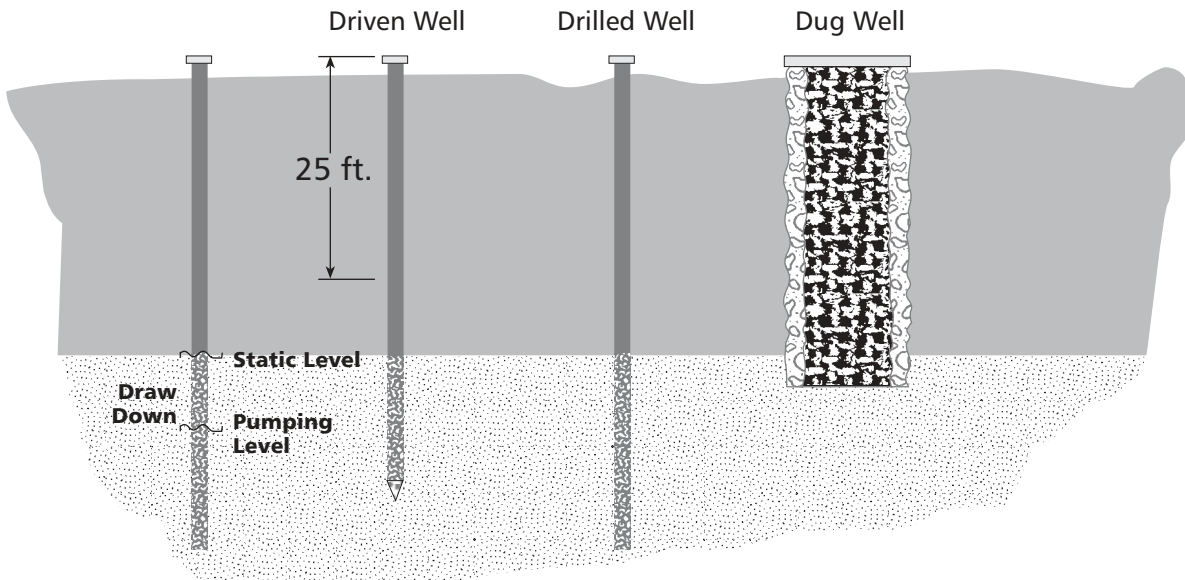

A Deep Well

Is any source of water where the low water level is more than 25 feet below the ground level.

Typical Jet Pump Installations

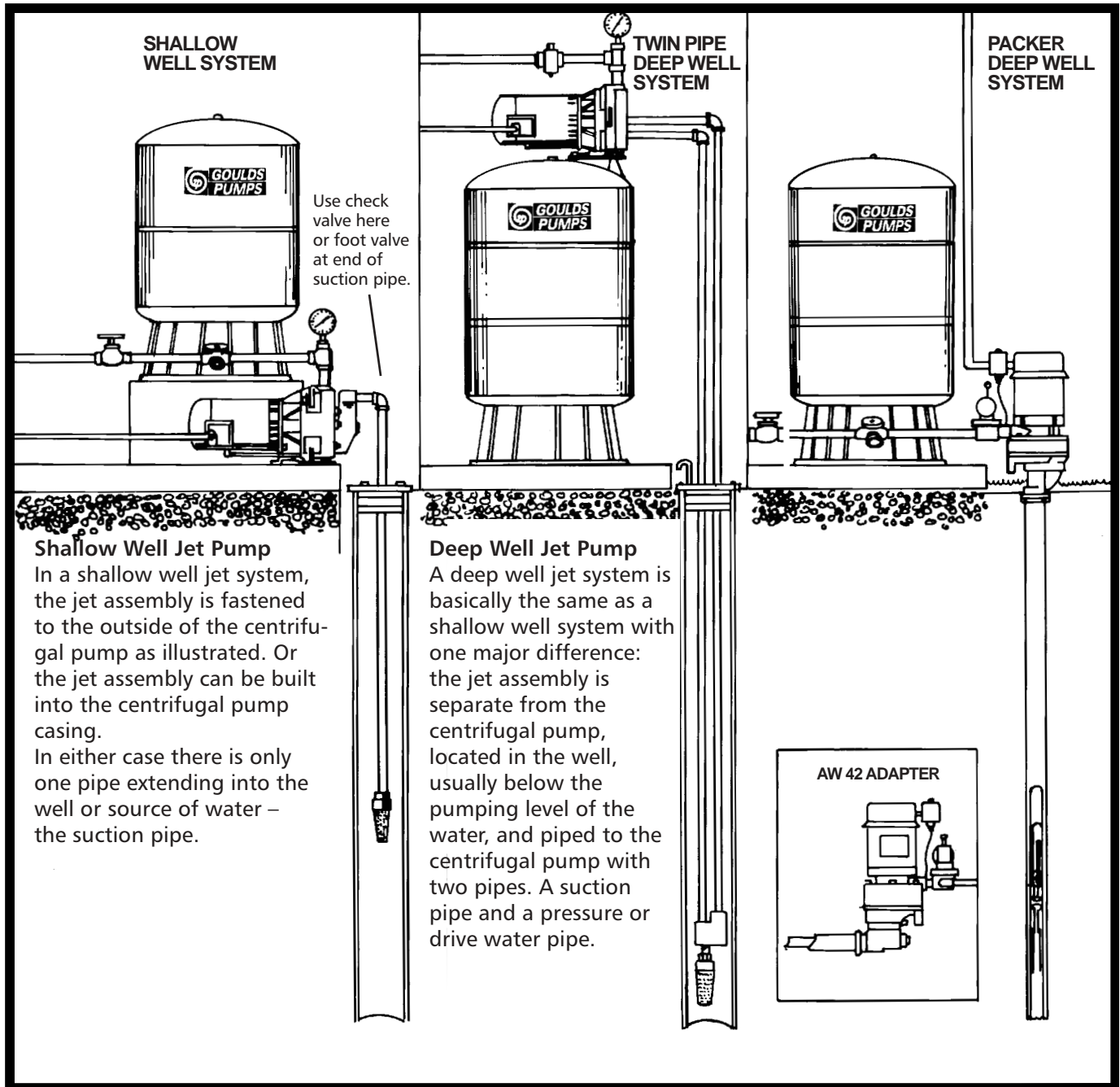

Typical Submersible Pump Installation

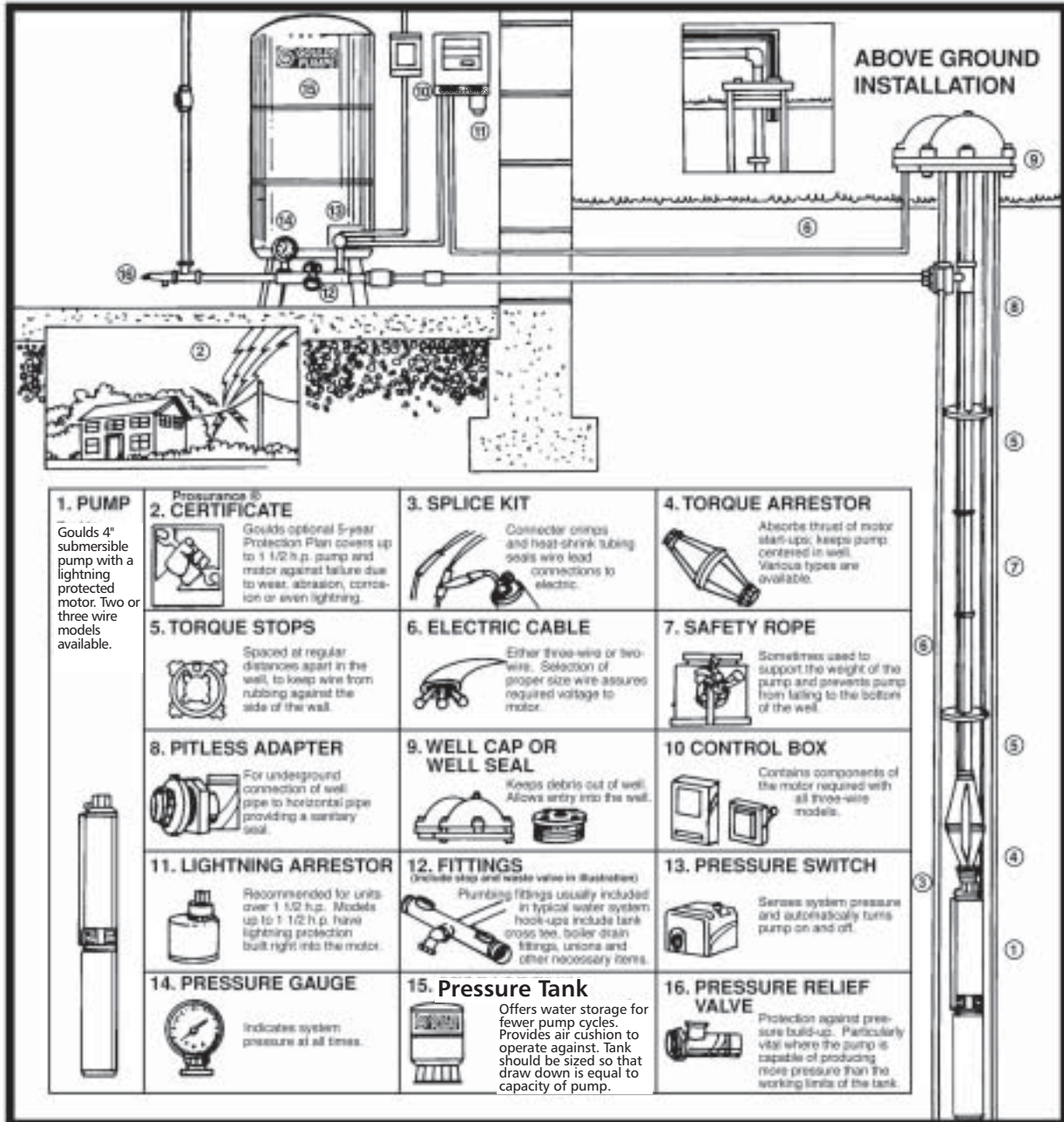

The 3 Basic Questions

1 Capacity Needed

How big must the pump be?

2 Well Conditions

Is a shallow or deep well pump needed?

3 Discharge Conditions

How much pressure is needed?

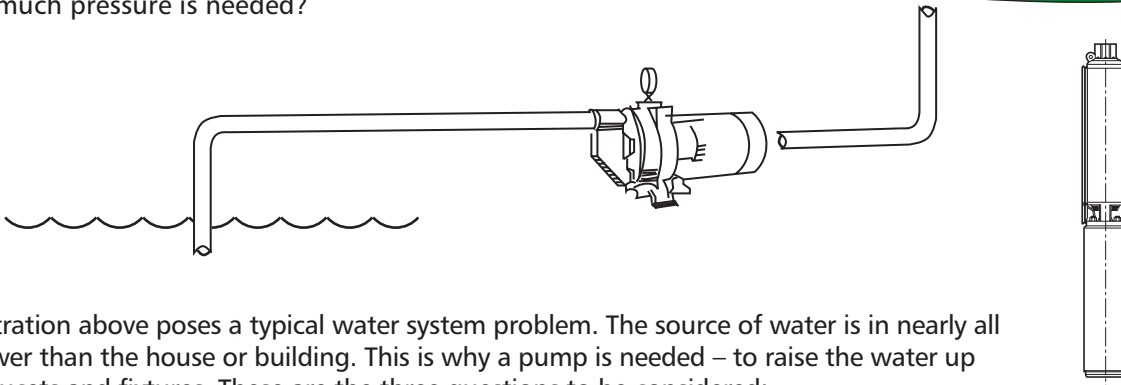

The illustration above poses a typical water system problem. The source of water is in nearly all cases lower than the house or building. This is why a pump is needed – to raise the water up to the faucets and fixtures. These are the three questions to be considered:

1 Capacity Needed

How much water in gallons per hour or gallons per minute are needed? This determines what size pump to use.

2 Well Conditions

What is the total suction lift? What is meant by “total suction”? We learn from this what to expect from a shallow well pump and when and why to use a deep well pump.

3 Discharge Conditions

How much pressure is needed at the pump? How much pressure will result at the faucet?

Whenever and wherever a pump is to be used, the correct answers to these three questions will tell the actual pumping conditions or specifically – what is required of the pump. With this information, you can always select the right pump from the catalog.

1 Capacity Needed

How much water is available?
 How much water is needed?
 How large must the pump be?

Limiting Factors

How much water is available? Before we select a pump based on need we must determine if the supply is adequate. Many areas have what we refer to as low yield wells, Well recovery rates may be as low as 1 GPM or less.

A typical low yield (1 – 2 GPM) well, cannot supply the 10-12 GPM required by an average home. If we pump at 12 GPM and the water enters the well at 2 GPM we will soon run the pump dry. This system would require a pump protection device to turn the pump off when it runs out of water.

Fortunately some low yield wells have a great deal of water stored in the well due to high static water levels. There are 500' deep wells with static water levels, when not being pumped, of 20'. A 4" well casing stores approximately .652 gallons per foot or 1.4 gallons per foot in a 6" well. In this case, a 4" well stores 312 gallons and a 6" stores 672 gallons. It is possible to use a 7 or 10 GPM pump and not over pump the well due to the large amount of water stored in the casing. While lawn watering and daily

multiple loads of laundry are out of the question, this application could provide a cost effective, reliable water supply without the use of large expensive storage tanks and booster pumps. The customer should be made aware of the limitations of the well and the options available.

If using a deep well jet pump in a low yield well you should use a 34' tail pipe on the bottom of the jet assembly. This will prevent over pumping a deep well. See the section on Using Tail Pipes in the Technical Manual of your catalog.

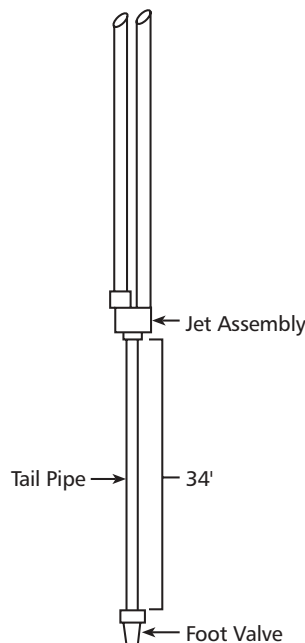

Another weak well scenario is to select a submersible pump sized for a maximum pumping depth somewhat less than the actual depth at which the pump will be installed. It will then be impossible for the pump to over pump the well and run dry. Another option is to install a low water level cut off system with electrodes to turn the pump off at a predetermined level. It can be set up to automatically reset when the water level rises. Unlike totally electronic protection devices the electrodes must be installed in the well.

If the source of supply is a deep cased well, the casing diameter and depth to water are limiting factors in how much water can be pumped. A 2" casing cannot accommodate a submersible pump. A 2" diameter limits you to a deep well jet pump with a packer or single pipe system. A 2" packer system can supply approximately 3.3 GPM from a 200' water level at 30 PSI. However, a submersible pump in a 4" diameter, 200' deep well can easily supply over 60 GPM at 60 PSI. Therefore, we can see that small diameter wells limit the available flow that can be

supplied. Small diameter, deep wells equal low capacity pumps. They also dictate the pump style that can be used.

Example:

Customer has a 2" well casing with a 100' pumping level. What is the correct pump and what will it produce?

The maximum pump capacity is about 9 GPM using a 2" packer assembly with a 2 HP, 2 stage jet pump.

In cases where we have no limiting factors, where we have all the water required and a well that will accommodate a reasonably sized pump. We can proceed to determine the correct capacity needed to satisfy the customers requirements.

Physical Restrictions

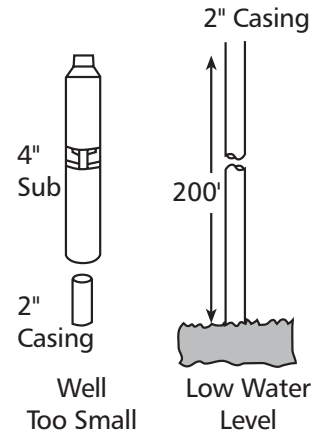

Goolds Pumps



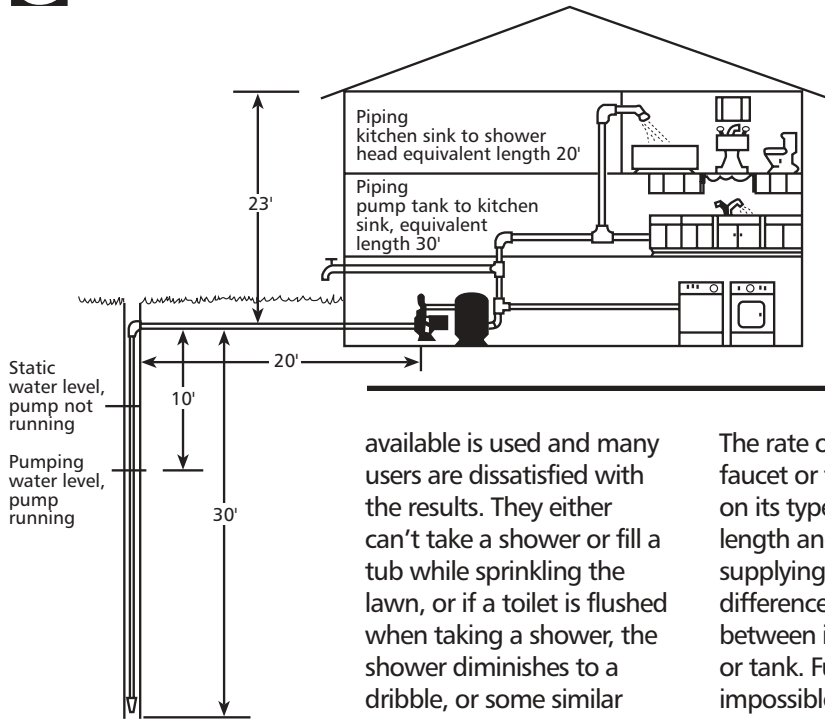

Demand

The capacity required of the pump is determined by the number of continuously flowing demands (showers, sprinkling, filling a tub or stock trough, etc.) which are likely to be in use at the same time with consideration given to a minimum rate of flow from each of these outlets which can be considered as satisfactory

Approximate Water Supply Requirements

Home Fixtures

- Filling Ordinary Lavatory – 2 gal.
- Filling avg. Bath Tub – 30 gal.
- Flushing Water Closet – 6 gal.
- Each Shower Bath – Up to 60 gal.
- Dishwashing Machine – 15 gal./load
- Automatic Laundry Machine – Up to 50 gal./load
- Backwashing Domestic Water Softener – Up to 100 gal.

Yard Fixtures

- ½" Hose with Nozzle – 3 gpm
- ¾" Hose with Nozzle – 5 gpm
- Lawn Sprinkler – 2 gpm

The capacity of a water system or pump determines its size. The bigger it is, the higher its price. Consequently, in many cases the smallest size

available is used and many users are dissatisfied with the results. They either can't take a shower or fill a tub while sprinkling the lawn, or if a toilet is flushed when taking a shower, the shower diminishes to a dribble, or some similar interruption occurs. The trouble of course is that the too small pump can't deliver water fast enough to supply the demand – its capacity is too little.

Determining how much capacity is required is not an exact science. The objective is to provide a water service similar to that available from a good city water system. This provides practically an unlimited rate of flow from any or all the faucets or other outlets either one at a time or all used at the same time. A home water system can provide this type service but there are few domestic well that will furnish such a quantity and it isn't at all likely that all the faucets in a home will be opened wide at the same time.

It can be assumed that in the average home any two faucets or outlets may be opened at once. The pump must have sufficient capacity to supply them. This will prevent the difficulty of not being able to use the shower when the kitchen sink is in use, and vice versa.

The rate of flow from a faucet or fixture depends on its type and size, the length and size of pipe supplying it and the difference in elevation between it and the pump or tank. Furthermore, it is impossible to determine by sight the exact rate of flow being delivered from a faucet.

It has been determined by test and by observation that the smallest or minimum rate of flow from a faucet should be about three gallons per minute (3 GPM). Any less than this approaches what appears to be a dribble; somewhat more is much more satisfactory. According to this, if a pump or water system in a home is to supply two faucets or outlets such as a shower and a kitchen sink at the same time, its capacity should be two times three or six gallons per minute (360 gallons per hour).

This of course is not always practical. The capacity of pumps changes with pumping conditions such as pumping level of the water and the operating pressure. Accordingly, it is good practice to provide a pump capacity for the average home of from 10 to 12 gpm when available.

The water from the pump or tank will not necessarily flow to fixtures or faucets at the rates just discussed. This is determined by the resistance to water flow in the house plumbing and is explained in the third step of the procedure – Discharge Conditions. It should, however, be obvious now that in order to use water from more than one outlet at a time, the capacity of the pump should be greater than the rate of flow in GPM available from any one faucet.

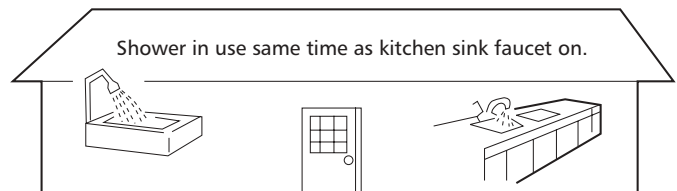

2 continuous uses require 6 G.P.M. minimum
The capacity required of the pump is determined by the number of continuous use outlets in use at the same time. You can't use water at one or a number of outlets any faster than the pump supplies it.

Goolds Pumps



The level of the water to be pumped is practically always below ground. It can be only a few feet as in a spring, shallow well, pond, etc., or it can be many feet as in a deep well. If we could always locate the pumping mechanism in the water, as we do with submersible pumps, our problem would be simpler because then the water would flow into the pump. However, standard electric motors and switches are not designed for submerged operation. Therefore they must be located above ground. This poses the question: How does the water get into the pump?

We call it suction, but what is it? What actually makes the water flow uphill into the pump? How high can we raise water by suction?

1. The atmosphere all around us has weight and therefore exerts pressure

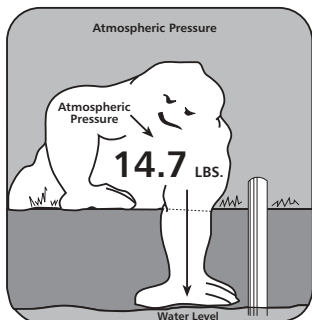

equal to about 14.7 lbs. per square inch at sea level. When the pressure of atmosphere is removed from inside of a pump the resulting condition is a vacuum or partial vacuum. It is also called suction.

The vacuum or suction chamber of a pump is piped (suction pipe) to a source of water. The surface of the water should be exposed to the pressure of atmosphere. When the pump operates it develops an unbalanced pressure condition due to the suction or vacuum it produces. This unbalanced pressure (14.7 lbs. per sq. in. atmospheric pressure on the surface of the water with vacuum or absence of pressure in the pump) causes water from the source to flow up the suction pipe into the pump. From this we can



Try to lift soda from a bottle by closing your mouth over the mouth of the bottle. It can't be done. When you use a straw, it is easy – you are creating a partial vacuum in your mouth, exposing the surface liquid to atmospheric pressure, the difference in pressure raises the liquid.

determine how high water can be raised by suction.

First, let's consider terms of measurement and their relation to each other.

Pressure is usually expressed in pounds per square inch (PSI).

Pressure is used to raise water to a height expressed in feet. This height is also expressed as feet head.

Vacuum is measured with a vacuum gauge. The gauge can be calibrated in feet suction lift or inches vacuum.

A. 1 inch vacuum equals 1.13 feet suction.

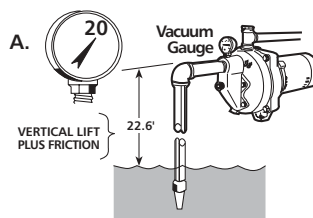

A reading of 20" on a vacuum gauge placed on a suction side of the pump would tell you that you had a vacuum or suction lift of 22.6 ft.

$$20" \times 1.13' = 22.6 \text{ ft.}$$

- B. 1 pound pressure equals 2.31 feet head.
- C. Atmospheric pressure of 14.7 x 2.31 = 33.9 ft. head, which is the maximum possible lift at sea level.

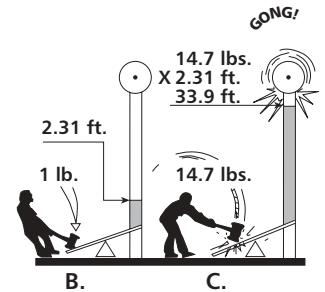

NOTE: You lose approximately one foot of suction lift per 1000 ft. of elevation.

Example: Denver, CO is approximately 5000 ft. above sea level. The total suction lift would only be 28.9 ft. not 33.9 ft. like at sea level.

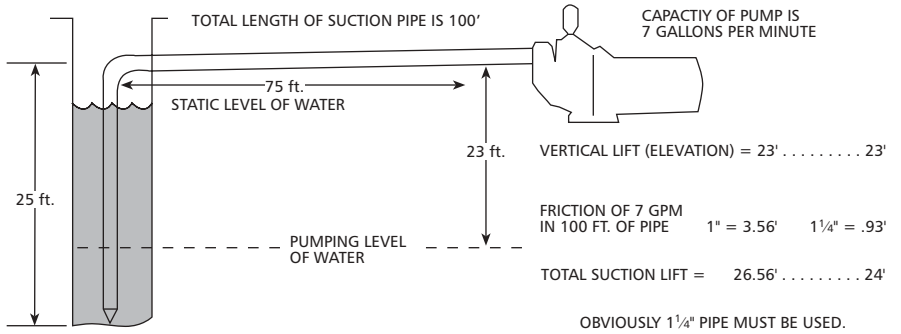

Summing this up: When the atmospheric pressure is 14.7 lbs. per sq. inch a perfect vacuum should be 30 inches and this would lift water by suction to a height of 33.9 ft. Most shallow well or suction pumps are capable of developing a near perfect vacuum, and at sea level they can lift water about thirty feet. However, suction lifts of more than 25 ft. at sea level are not recommended. Shallow well jet pumps deliver inadequate capacity on lifts over 25 ft. Suction conditions, or total suction lift must include all resistances to the flow of the water through the suction pipe up to the pump. Height or vertical lift is one resistance. Friction between the water and the pipe walls is the other resistance.

Friction Loss
When water flows through pipe, the inner wall of the pipe resists the flow of the water. This resistance is called pipe friction.

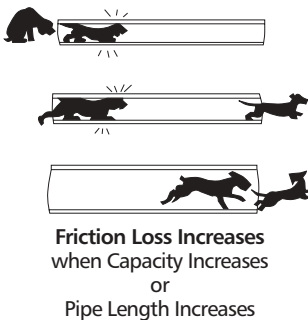

Pipe friction means extra work for the pump or system and presents a total loss. Therefore, it is desirable to keep friction loss as low as is practicable in order to

waste the least possible amount of work. Keep in mind that all work being done on the suction side of the pump is actually performed by the pressure of atmosphere. Since in common practice we consider this pressure is sufficient to overcome only 25 ft., the 25 ft. must always include any losses due to friction. We don't have to be too concerned with how or why friction loss is incurred, but it is essential that we accept it as occurring always when water flows through pipes. It is, also, most essential that we understand how it is measured. In our discussion of suction lift, atmospheric pressure and the height this pressure will raise water, we established the fact that 14.7 lb.

pressure will raise water to a height of 33.9 ft. Although there is no relation between atmospheric pressure and friction loss, the relation between pounds pressure and feet elevation or head as we call it, is the same whether the pressure is coming from atmosphere or any other source. So, as stated before, 14.7 lbs. pressure from any source will raise water 33.9 ft. and this gives us the conversion factor to change our terms from pressure to feet or the reverse of this. Therefore, 1 lb. of pressure is always equal to 2.31 ft. (33.9 divided by 14.7 equals 2.31). Now getting back to friction loss, the amount of this loss increases as the quantity of water flowing through a given size pipe is increased. There are formulas to

determine the amount of flow and any pipe size. But we don't have to be concerned with this, since it has all been carefully calculated and set up in the friction loss table as shown below. **Example:** The example at the top of the page shows that using the correct size pipe will reduce friction loss. On some jobs, a smaller pump with larger pipe will do the same work (flow) as a larger pump with smaller pipe. Larger pipe is not much more expensive but larger pumps are. Larger pumps also use more energy. Using the correct pipe size saves money in the long run. Calculating friction loss is especially important if you are not sure of the well drawdown. It is a very good rule of thumb to always use a suction pipe that is the same size or larger than the pump suction.

Friction of Water per Each 100 Feet of New Steel Pipe

GPM	GPH	3/8" Pipe		1/2" Pipe		3/4" Pipe		1" Pipe		1 1/4" Pipe		1 1/2" Pipe		2" Pipe		2 1/2" Pipe		3" Pipe		4" Pipe		
		Ft.	Lbs.	Ft.	Lbs.	Ft.	Lbs.	Ft.	Lbs.	Ft.	Lbs.	Ft.	Lbs.	Ft.	Lbs.	Ft.	Lbs.	Ft.	Lbs.	Ft.	Lbs.	
1	60	4.30	1.86	1.86	.81	0.26	0.11															
2	120	15.00	6.49	4.78	2.07	1.21	0.52	0.38	0.16													
3	180	31.80	13.77	10.00	4.33	2.50	1.08	0.77	0.33													
4	240	54.90	23.77	17.10	7.40	4.21	1.82	1.30	0.56	0.34	0.15											
5	300	83.50	36.45	25.80	11.17	6.32	2.74	1.93	0.84	0.51	0.22	0.24	0.10									
6	360			36.50	15.80	8.87	3.84	2.68	1.16	0.70	0.30	0.33	0.14	0.10	0.04							
7	420			48.70	21.08	11.80	5.11	3.56	1.54	0.93	0.40	0.44	0.19	0.13	0.06							
8	480			62.70	27.14	15.00	6.49	4.54	1.97	1.18	0.51	0.56	0.24	0.17	0.07							
9	540					18.80	8.14	5.65	2.45	1.46	0.63	0.69	0.30	0.21	0.09							
10	600					23.00	9.96	6.86	2.97	1.77	0.77	0.83	0.36	0.25	0.11	0.11	0.05	0.04	0.02			
12	720					32.60	14.11	9.62	4.16	2.48	1.07	1.16	0.50	0.34	0.15	0.15	0.06	0.05	0.02			
15	900					49.70	21.52	14.70	6.36	3.74	1.62	1.75	0.76	0.52	0.23	0.22	0.10	0.08	0.03			
20	1200					86.10	37.27	25.10	10.87	6.34	2.74	2.94	1.27	0.87	0.38	0.36	0.16	0.13	0.06			
25	1500							38.60	16.71	9.65	4.18	4.48	1.94	1.30	0.56	0.54	0.23	0.19	0.08			
30	1800							54.60	23.64	13.60	5.89	6.26	2.71	1.82	0.79	0.75	0.32	0.26	0.11			
35	2100							73.40	31.77	18.20	7.88	8.37	3.62	2.42	1.05	1.00	0.43	0.35	0.15			
40	2400							95.00	41.13	23.50	10.17	10.79	4.67	3.10	1.34	1.28	0.55	0.44	0.19			
45	2700									30.70	13.29	13.45	5.82	3.85	1.67	1.60	0.69	0.55	0.24			
50	3000									36.00	15.58	16.40	7.10	4.67	2.02	1.94	0.84	0.66	0.29	.18	.08	
70	4200									68.80	29.78	31.30	13.55	8.86	3.84	3.63	1.57	1.22	0.53	.35	.15	
100	6000											62.20	26.93	17.40	7.53	7.11	3.08	2.39	1.03	.63	.27	
150	9000													38.00	16.45	15.40	6.67	5.14	2.23	1.32	.57	
200	12000													66.30	28.70	26.70	11.56	8.90	3.85	2.27	.98	
250	15000													90.70	39.26	42.80	18.53	14.10	6.10	3.60	1.56	
300	18000															58.50	25.32	19.20	8.31	4.89	2.12	
350	21000															79.20	34.29	26.90	11.65	6.72	2.91	

3 Discharge Conditions

What are the conditions under which the water system must discharge its capacity?

The capacity of the pump has already been established so we are now concerned only with the pressure required of the system.

It seems that the pressure and its use in a domestic water system are generally misunderstood, so perhaps some explanation is in order. Quite often it is stated that a particular pump is delivering sufficient capacity but fails to develop adequate pressure. In most cases this is a misstatement and the opposite condition is true. This complaint is generally made when a particular system fails to provide sufficient flow through several outlets at the same time. This is caused in most cases by the demand in rate of flow being greater than the capacity of the system. If the system has sufficient capacity to supply the maximum number of outlets which are likely to be used at the same time, our only concern with pressure is that we have sufficient pressure to overcome the resistance to flow which will be encountered. If you have any doubts about this, consider your answer to this question:

Would you rather have at a faucet one gallon per minute at a hundred pounds pressure or ten gallons per minute at ten pounds pressure? Which will fill a tub quicker?

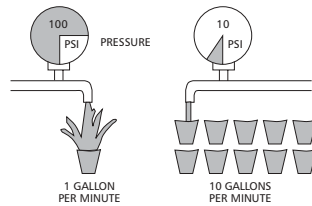

Now as to the resistance to flow which will be encountered, there are three causes. These are (1) the resistance by the outlet itself such as a partially rusted shower head, (2) friction loss in pipe lines, and (3) that resistance due to difference in elevations.

Actually none of these will have to be computed in most applications because usually the pump is installed at the house, and the standard pressure range of the system is sufficient to overcome these resistances and deliver its capacity to the various outlets. An example in which these computations must be made is when the pump or system is located at considerable distance from the point of use and on a lower elevation.

In such a case the difference in elevation must be determined (1 lb. Pressure is necessary to overcome each 2.3 ft. elevation); the

friction loss in feet calculated and changed to pounds pressure (again the same relation, 1 lb. Pressure equals 2.3 ft. or this can be read directly from the table in lbs.); the service pressure or pressure required at the faucet must be decided; the total of these three will be the discharge conditions or operating pressure required of the pump.

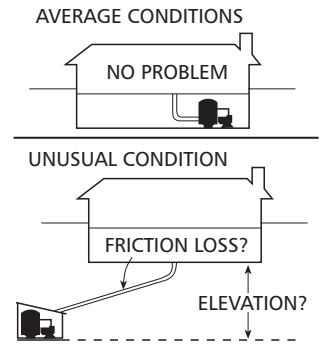

Example

- Service pressure desired – 30 lbs. min 30 lbs.
- Elevation 23 ft.
1 lb. = 2.3 ft.
23 ft. / 2.3 ft. = 10 lbs. ... 10 lbs.
- Friction:
Pump capacity is 7 gpm
This flow through 200 ft. of 1" pipe gives a friction loss of 3.06 lbs. 3 lbs.
43 lbs.
- Pressure switch setting at the pump would be (43-63 lbs.)

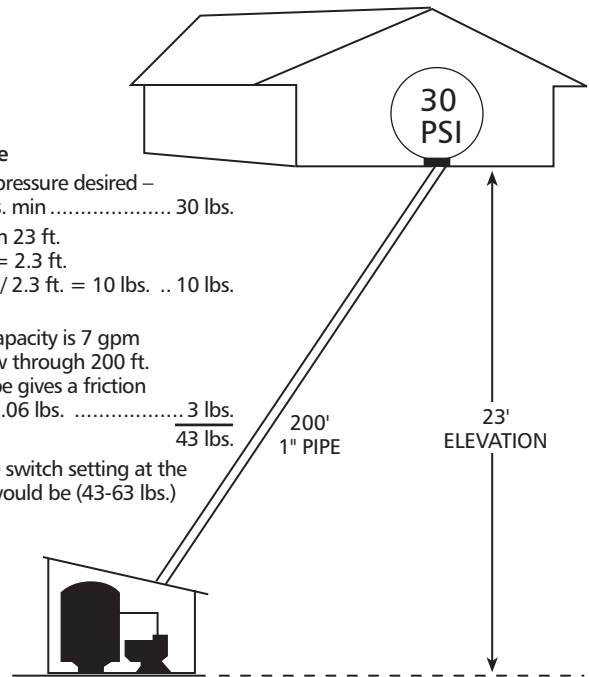

This means when the pressure switch cuts the pump on at about 43 lbs. Tank pressure, the pressure at the house will be 30 lbs. When the water is flowing at a rate of 7 gallons per minute.

Jet Systems

The first question with Jet Pumps is what is the suction chamber and how is the vacuum created.

The Jet Assembly itself forms the suction chamber and the vacuum is created by the very high velocity of a stream of water passing through the jet. Basically, the jet assembly is composed of two parts. First, a nozzle which produces the high velocity stream of water. This high velocity stream of water is injected through a small compartment which is the suction chamber, thereby causing the vacuum. Obviously, the suction pipe is connected to this compartment or suction chamber. The vacuum caused by the jet permits the greater pressure of atmosphere on the surface of a body of water to force water into the suction chamber.

The second basic part of the Jet Assembly is the venturi tube. It is installed in the discharge of the suction chamber. Its function is to convert the velocity of the water into pressure. This is accomplished by the shape of its water passage. Perhaps you can best visualize this by thinking of a nozzle in reverse. The nozzle speeds up the flow of the drive water converting pressure into velocity and when it has passed through the suction chamber, the venturi slows it down again converting the velocity back into pressure.

“Drive water” is that water which is piped under pressure to the jet assembly or suction chamber. The discharge from the suction chamber or jet assembly is composed of both the drive water and that water pumped from the well. The total amount pumped from the well can be used as discharge from the system and is the output or capacity.

Shallow Well Jet Pump

From the foregoing discussion it is obvious that the operation of the Jet system is dependent on the combined functions of both the Jet Assembly or suction chamber and the centrifugal pump. Also, that these two main components of the system are entirely separate and their locations with respect to each other is a matter of design.

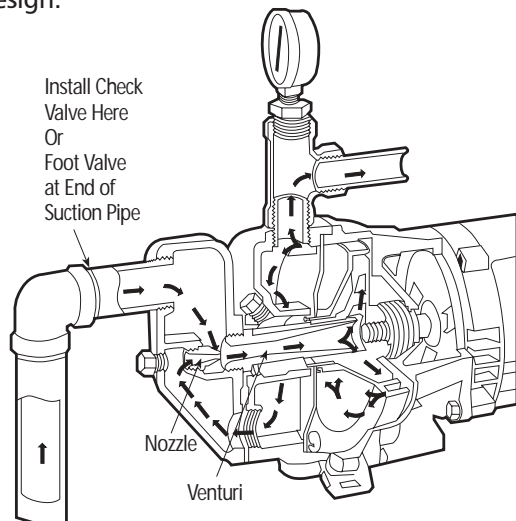

In shallow well jet pumps the jet assembly is built into the pump casing as in the Goulds Pumps J5S. Or, the jet assembly, shallow well adapters, can be bolted to the centrifugal pump. In either case there is only one pipe extending into the well . . . the suction pipe.

Deep Well Jet Pump

The only basic or fundamental difference between Shallow Well and Deep Well Jet Pumps is the location of the Jet Assembly. It must always be located in such a position that the total suction lift between it and the pumping level of the water to be pumped does not exceed that which can be overcome by the pressure of atmosphere. This, of course, means that when this pumping level is at a distance lower than the ground level which cannot be overcome by atmospheric pressure, the Jet Assembly must be located at least five feet below the low water in the well.

We must have a closed compartment in which to install the nozzle and the venturi and to form the suction chamber. This part is called the jet body. Its shape is such that it will fit into the casing of a drilled well and the pipe connections are located for accessibility. There are two on the top side, one for connection to the pressure pipe which supplies the drive water, the other for connection to the suction pipe which returns both the drive water and the water pumped from the well. For this reason, this connection is one pipe size larger than that for the pressure pipe. Water from the well enters through a third opening which is on the bottom side of the jet body.

The last accessory for the Jet System is the pressure control valve. It is a valve installed in the discharge piping from the centrifugal pump between the pump and the tank; in the pump when the pump is mounted on a tank. Used only in deep well systems, its purpose is to assure a minimum operating pressure for the jet.

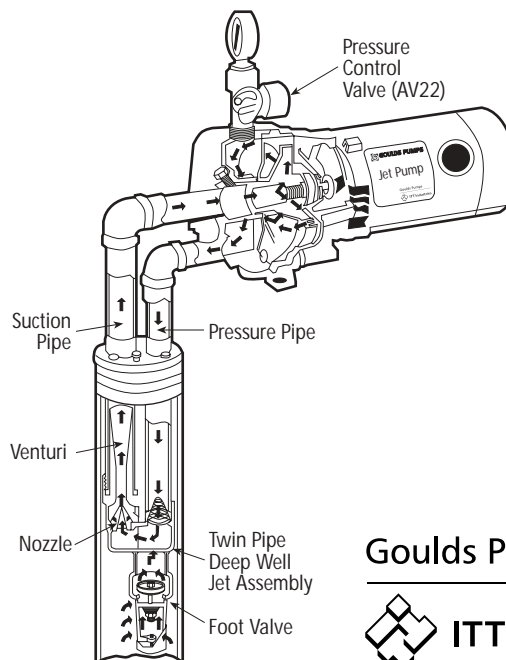

Goulds Pumps



Submersible Pump

Submersible pumps are so named because the whole unit, pump and motor is designed to be operated under water. This means the pump does not have to be primed. Once installed and turned on, water flows up the pipe.

The pump end is a multistage (many impellers) centrifugal pump, close coupled to a submersible electric motor. All of the impellers of the multistage submersible rotate in the same direction by a single shaft. Each impeller sits in a bowl and the flow from the impeller is directed to the next impeller through a diffuser. These three parts (bowl, impeller and diffuser) are known as a stage.

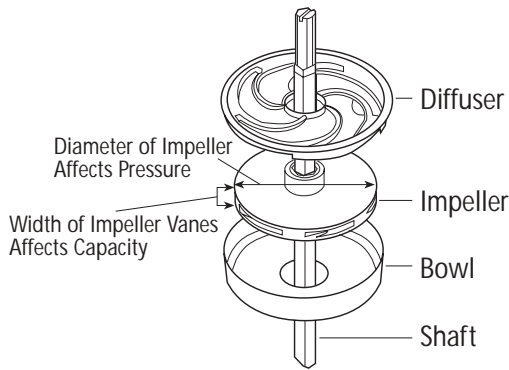

The capacity of a multistage centrifugal pump (submersible) is largely determined by the width of the impeller and diffuser, regardless of the number of stages. The pressure is determined by the diameter of the impeller, the speed at which it rotates and the number of impellers. The diameter is limited to the size of wells drilled. Most submersibles are designed to fit in four or six inch wells (or larger).

A ½ HP pump with seven impellers (designed for capacity) would deliver more water at 80' than a ½ HP pump with 15 impellers (designed for pressure) but the latter pump would be able to raise water from a greater depth.

Well water enters the unit through screened openings at the middle of the unit between the pump and motor. There is only one pipe connection which is at the top of the pump. This is the discharge pipe. A check valve is located at the top of the unit to prevent water from the system draining back when the pump isn't running.



Submersible pumps are so much more efficient than jet pumps and the installation so much simpler that a submersible pump should be considered first for all pump applications where the physical dimensions of the source of the water will accommodate the unit in a submerged position.

Example: 60 ft. pumping level;
30-50 lbs. Pressure.

½ HP submersible	11 gpm
½ HP jet system	6 gpm

Centrifugal Pump

The centrifugal pump does two things. It circulates the drive water at the pressure required to produce the necessary velocity in the Jet. It also boosts the pressure of that water being pumped from the well delivering it through the discharge of the system at a satisfactory service pressure. Since the one return pipe from the jet assembly contains both these quantities of water, this return pipe is connected direct to the suction opening of the centrifugal pump. The action of the centrifugal pump can be thought of as that of a paddlewheel. The impeller is a multi-vane (or blade) wheel and its design is such that its size, shape and speed impart sufficient energy to the water in the system to circulate it at the desired rate.

As the water is discharged from the centrifugal pump, it is divided. The drive water, or that amount required to operate the Jet is piped directly to the Jet through the pressure pipe. It is continuously recirculated so long as the centrifugal pump is running. That amount pumped from the well is discharged from the centrifugal pump directly into the tank and is the capacity of the system.

Centrifugal Pump Characteristics

- Impeller attached to a Motor/Driver
- Impeller draws the HP off the Motor/Driver
- Flexible machine; capable of a range of performances at good efficiencies
- Will overload motor (pumps max. capacity)
- Limited Suction Lift capability (15-25')
- Impeller makes own pressure (PSI)
- Adds its pressure to any incoming pressure
- Poor air-handling capability (Cavitation, loss of suction/prime, and air-binding)



When applying a pump to any specific problem pertaining to domestic water supply, our objective in practically every case should be to provide automatic running water under pressure – a water service comparable to that which might be expected from connection to a city water main. But, a pump alone can hardly perform the several necessary functions. Certain other accessories are necessary, and the combination of them all forms what we call a water system.

Motors

The first accessory is the drive medium which on practically all water systems of today is an electric motor. You should remember that some of our pumps, in particular the jet pumps in large motor sizes and submersible pumps, are furnished with motors of current characteristics as specified. Therefore, when ordering these, we must be advised the electrical characteristics.

Pressure Switch

The next accessory required is a pressure switch to start and stop the motor automatically at a predetermined pressure. A tube connects the switch to some point in the system on the discharge side of the pump. The pressure in the system then acts directly on a diaphragm in the switch which in turn actuates the contacts in the switch.

Pressure Tanks

The rate at which water can be used in a home, school, motel, or any other place can be as little as one gallon a minute (60 gallons per hour) (brushing teeth or rinsing hands). Or the maximum can be hundreds or thousands of gallons per hour depending on the number of water using fixtures and, or appliances in use at the same time.

A pump capable of delivering a capacity equal to the maximum demand cannot necessarily be throttled to the minimum demand.

The main purposes of a pressure tank are to pressurize the system to make it operate automatically and to properly cycle the pump to properly cool the motor. This prevents excessive short cycling (too rapid starting and stopping). The pump capacity and size motor should

always be considered. The larger a motor is in horsepower the more starting power required; therefore, the less frequently it should be started.

It is good practice to size the tank to require the pump to run at least one minute per cycle when using fractional horsepower motors and two to three minutes for larger motors.

There are three basic types of tanks in use today.

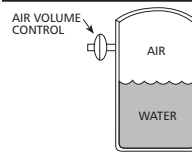

Conventional or Galvanized Type
Requires an air volume control device to keep proper amount of air cushion in the tank.

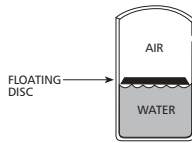

Floating Disc Type
Disc helps in preventing water from absorbing air but is not absolute. It requires periodic replenishment of air through air valve.

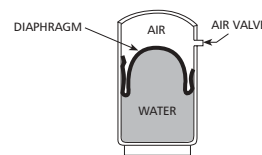

Sealed Diaphragm Type
Water and air are permanently separated by sealed diaphragm; therefore, the amount of air never changes. The amount of draw-off also never changes.

Relief Valve

As a precaution or protection against the possibility of the switch becoming stuck at some time allowing the pump to continue running after sufficient pressure has been obtained, a relief valve is necessary with all systems capable of developing pressures in excess of the working limits of the tank. A relief valve is a spring controlled valve located somewhere close to or in the pump on the discharge side, or on the tank. The tension of the spring is so adjusted that it will permit the valve to open and allow the water to escape if the pressure in the system exceeds by more than about 10 lbs. That at which the pressure switch is set to cut off the current to the motor.

Foot Valve

A foot valve is a combination check valve and strainer.

Now let's summarize briefly the points we've covered. We have shown that in a water system application, there are three factors to consider:

1. Water Needed or Determination of Capacity
2. Suction Conditions, and
3. Discharge Conditions.

We have concluded that capacity required is determined by the maximum number of outlets which will be in continuous use at the same time with a minimum flow of three gallons per minute per outlet.

We have shown that all jet pumps, whether shallow well or deep well, have a water end in which there is a suction chamber; that the suction chamber is actually a closed container in which a partial vacuum is created. This allows atmospheric pressure to force in the

water. The suction chamber must be located within about 25 feet vertical distance above the pumping level of the water.

The main difference between shallow well and deep well pumps is that in the former the water end is built onto the power end. The water end of deep well jet pumps is a separate part. It is installed in the water and is used to pump water from levels below a 25 feet depth. We have shown that a submersible should be used when source will allow. Since the submersible is submerged in water only discharge conditions apply. We've established three distinct forms of resistance to flow encountered as Discharge Conditions and shown that they must be considered but computed only in special cases. Also, that the

pump is only part of the system necessary to provide an automatic service. Other accessories are necessary and we've established the need and function of each of these accessories.

We have mentioned 3 GPM as a minimum acceptable flow rate per outlet. But a larger flow rate is more desirable and the following table should be used as an average supply required when the source of supply will allow it.

We would like to leave you with one thought. That is, capacity and pressure are inversely related. When one goes up, the other goes down. Always check the rating chart or curve of a pump to make sure if you raise the pressure you will still receive the needed supply of water at your outlets.

Using the rating chart below, we would be getting 8 GPM from the pump at 20 lbs. pressure. If we were trying to supply two outlets at once, this would give us approximately 4 GPM at each one. If we increase the pressure to 30 lbs. pressure, we only get 6 GPM which will give us approximately 3 GPM at each outlet. By raising the pressure we have reduced the amount of water at each outlet by approximately 25%.

Always check the pump performance rating before making a change.

Performance Rating in Gallons per Minute

Pump Discharge Pressure			
Total Suction Lift	20 PSI	30 PSI	Max. Shut-Off in Lbs.
5 feet	8 GPM	6 GPM	51 lbs.

Seven Minute Peak Demand Period Usage

Outlets	Flow Rate GPM	Total Usage Gallons	Bathrooms In Home			
			1	1½	2-2½	3-4
Shower or Bath Tub	5	35	35	35	53	70
Lavatory	4	2	2	4	6	8
Toilet	4	5	5	10	15	20
Kitchen Sink	5	3	3	3	3	3
Automatic Washer	5	35	-	18	18	18
Dishwasher	2	14	-	-	3	3
Normal seven minute*peak demand (gallons)			45	70	98	122
Minimum sized pump required to meet peak Demand without supplemental supply			7 GPM (420)	10 GPM (600)	14 GPM (840)	17 GPM (1020)

Note: Values given are average and do not include higher or lower extremes. * Peak demand can occur several times during morning and evening hours.

Additional Requirements: Farm, irrigation and sprinkling requirements are not shown. These values must be added to the peak demand figures if usage will occur during normal demand periods.

Goulds Pumps



1. What well conditions might possibly limit the capacity of the pump?	Rate of flow from the source of supply, the diameter of a cased deep well and the pumping level of the water in a cased deep well.
2. How does the diameter of a cased deep well and pumping level of the water affect the capacity?	Limits the size pumping equipment which can be used.
3. If there are no limiting factors, how is capacity determined?	Maximum number of outlets or faucets likely to be in use at the same time.
4. What is suction?	A partial vacuum created in suction chamber of pump obtained by removing pressure due to atmosphere, thereby allowing greater pressure outside to force something (air, gas, water) into the container.
5. What is atmospheric pressure?	The atmosphere surrounding the earth presses against the earth and all objects on it, producing what we call atmospheric pressure.
6. How much is the pressure due to atmosphere?	This pressure varies with elevation or altitude. It is greatest at sea level (14.7 lbs. Per sq. in.) and gradually decreases as elevation above sea level is increased. At the rate of approximately 1 foot per 1000 feet of elevation.
7. What is maximum theoretical suction lift?	Since suction lift is actually that height to which atmospheric pressure will force water into a vacuum, theoretically we can use the maximum amount of this pressure 14.7 lbs. per sq. in. at sea level which will raise water 33.9 ft. From this, we obtain the conversion factor of 1 lb. per sq. in. of pressure equals 2.31 ft. head.
8. How does friction loss affect suction conditions?	The resistance of the suction pipe walls to the flow of water uses up part of the work which can be done by atmospheric pressure. Therefore, the amount of loss due to friction in the suction pipe must be added to the vertical elevation which must be overcome and the total of the two must not exceed 25 feet sea level. This 25 feet must be reduced 1 foot for every 1,000 feet elevation above sea level which corrects for a lessened atmospheric pressure with increased elevation.
9. When and why do we use a deep well jet pump?	When the water level is more than 25 feet below the pump because this is the maximum practical suction lift which can be obtained with a shallow well pump at sea level.

10. What do we mean by water system?	A pump with all necessary accessories, fittings, etc., necessary for its completely automatic operation.
11. What is the purpose of a foot valve?	It is used on the end of a suction pipe to prevent the water in the system from running back into the source of supply when the pump isn't operating.
12. Name the two basic parts of a Jet Assembly.	Nozzle and Venturi.
13. What is the function of the nozzle?	The nozzle converts the pressure of the drive water into velocity. The velocity thus created causes a vacuum in the Jet Assembly or suction chamber.
14. What is the purpose of the venturi?	The venturi converts the velocity from the nozzle back into pressure.
15. What do we mean by "drive water"?	That water which is supplied under pressure to drive the jet.
16. What is the source of the "drive water"?	The drive water is continuously recirculated in a closed system.
17. What is the purpose of the centrifugal pump?	The centrifugal pump provides the energy to circulate the drive water. It also boosts the pressure of the discharged capacity.
18. Where is the Jet Assembly usually located in a Shallow Well Jet System?	Bolted to the casing of the centrifugal pump.
19. What is the principal factor which determines if a shallow well jet system can be used?	A maximum suction lift of 25' at sea level.
20. When is a deep well jet system used?	When the total suction lift exceeds 25'.
21. Can a foot valve be omitted from a Deep Well Jet System? Why?	No, because there are no valves in the Jet Assembly and the foot valve is necessary to hold water in the system when it is primed. Also, when the centrifugal pump isn't running, the foot valve prevents the water from running back into the well.
22. What is the function of a check valve in the top of a submersible pump?	To hold the pressure in the line when the pump isn't running.
23. A submersible pump is made up of two basic parts. What are they?	Pump end and motor.
24. Why did the name submersible pump come into being?	Because the whole unit, pump and motor, is designed to be operated under water.

25. A submersible pump can be installed in a 2" well?	No, they required a 4" well or larger for most domestic use. Larger pumps with larger capacities require 6" wells or larger.
26. A stage in a submersible pump is made up of three parts. What are they?	Impeller, diffuser and bowl.
27. A submersible pump has only one pipe connection?	True, for the discharge pipe.
28. What are two reasons we should always consider using a submersible first?	It will pump more water at higher pressure with less horsepower. Easier installation.
29. The amount of pressure a pump is capable of making is controlled by what?	The diameter of the impeller.
30. The width of an impeller and guide vane control what?	The amount of water or capacity the pump is capable of pumping.

Friction of Water PER EACH 100 FEET of New Steel Pipe

GPM	GPH	3/8" Pipe		1/2" Pipe		3/4" Pipe		1" Pipe		1 1/4" Pipe		1 1/2" Pipe		2" Pipe		2 1/2" Pipe		3" Pipe		4" Pipe	
		Ft.	Lbs.	Ft.	Lbs.	Ft.	Lbs.	Ft.	Lbs.	Ft.	Lbs.	Ft.	Lbs.	Ft.	Lbs.	Ft.	Lbs.	Ft.	Lbs.	Ft.	Lbs.
1	60	4.30	1.86	1.86	.81	0.26	0.11														
2	120	15.00	6.49	4.78	2.07	1.21	0.52	0.38	0.16												
3	180	31.80	13.77	10.00	4.33	2.50	1.08	0.77	0.33												
4	240	54.90	23.77	17.10	7.40	4.21	1.82	1.30	0.56	0.34	0.15										
5	300	83.50	36.45	25.80	11.17	6.32	2.74	1.93	0.84	0.51	0.22	0.24	0.10								
6	360			36.50	15.80	8.87	3.84	2.68	1.16	0.70	0.30	0.33	0.14	0.10	0.04						
7	420			48.70	21.08	11.80	5.11	3.56	1.54	0.93	0.40	0.44	0.19	0.13	0.06						
8	480			62.70	27.14	15.00	6.49	4.54	1.97	1.18	0.51	0.56	0.24	0.17	0.07						
9	540					18.80	8.14	5.65	2.45	1.46	0.63	0.69	0.30	0.21	0.09						
10	600					23.00	9.96	6.86	2.97	1.77	0.77	0.83	0.36	0.25	0.11	0.11	0.05	0.04	0.02		
12	720					32.60	14.11	9.62	4.16	2.48	1.07	1.16	0.50	0.34	0.15	0.15	0.06	0.05	0.02		
15	900					49.70	21.52	14.70	6.36	3.74	1.62	1.75	0.76	0.52	0.23	0.22	0.10	0.08	0.03		
20	1200					86.10	37.27	25.10	10.87	6.34	2.74	2.94	1.27	0.87	0.38	0.36	0.16	0.13	0.06		
25	1500							38.60	16.71	9.65	4.18	4.48	1.94	1.30	0.56	0.54	0.23	0.19	0.08		
30	1800							54.60	23.64	13.60	5.89	6.26	2.71	1.82	0.79	0.75	0.32	0.26	0.11		
35	2100							73.40	31.77	18.20	7.88	8.37	3.62	2.42	1.05	1.00	0.43	0.35	0.15		
40	2400							95.00	41.13	23.50	10.17	10.79	4.67	3.10	1.34	1.28	0.55	0.44	0.19		
45	2700									30.70	13.29	13.45	5.82	3.85	1.67	1.60	0.69	0.55	0.24		
50	3000									36.00	15.58	16.40	7.10	4.67	2.02	1.94	0.84	0.66	0.29	.18	.08
70	4200									68.80	29.78	31.30	13.55	8.86	3.84	3.63	1.57	1.22	0.53	.35	.15
100	6000											62.20	26.93	17.40	7.53	7.11	3.08	2.39	1.03	.63	.27
150	9000													38.00	16.45	15.40	6.67	5.14	2.23	1.32	.57
200	12000													66.30	28.70	26.70	11.56	8.90	3.85	2.27	.98
250	15000													90.70	39.26	42.80	18.53	14.10	6.10	3.60	1.56
300	18000															58.50	25.32	19.20	8.31	4.89	2.12
350	21000															79.20	34.29	26.90	11.65	6.72	2.91

From the table, give the friction loss *in ft.* for the following conditions:

- | | | | | | |
|------------------|---|------------------|------------------|------------------|---------|
| | | $\frac{3}{4}$ " | $1\frac{1}{4}$ " | 2" | |
| 100 Feet of Pipe | } | 1. 360 GPH | a _____ | b _____ | c _____ |
| | | 2. 600 GPH | a _____ | b _____ | c _____ |
| | | $\frac{3}{4}$ " | $1\frac{1}{4}$ " | 2" | |
| 50 Feet of Pipe | } | 3. 420 GPH | a _____ | b _____ | c _____ |
| | | 4. 600 GPH | a _____ | b _____ | c _____ |
| | | $\frac{1}{2}$ " | 1" | $1\frac{1}{2}$ " | |
| 150 Feet of Pipe | } | 5. 240 GPH | a _____ | b _____ | c _____ |
| | | 6. 480 GPH | a _____ | b _____ | c _____ |
| | | $\frac{3}{4}$ " | 1" | $1\frac{1}{4}$ " | |
| 80 Feet of Pipe | } | 7. 360 GPH | a _____ | b _____ | c _____ |
| | | 8. 600 GPH | a _____ | b _____ | c _____ |

1.

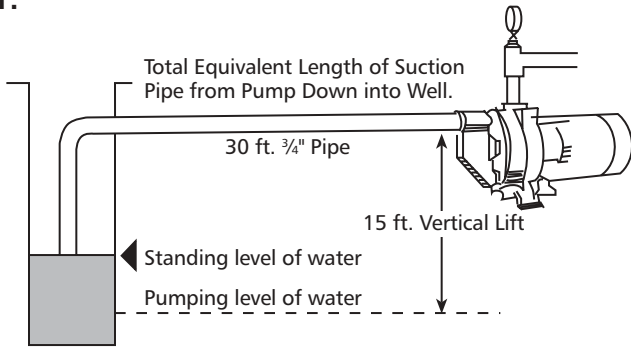

Pump Capacity 6 GPM

- a. What is friction loss? _____
- b. What is total lift? _____

2.

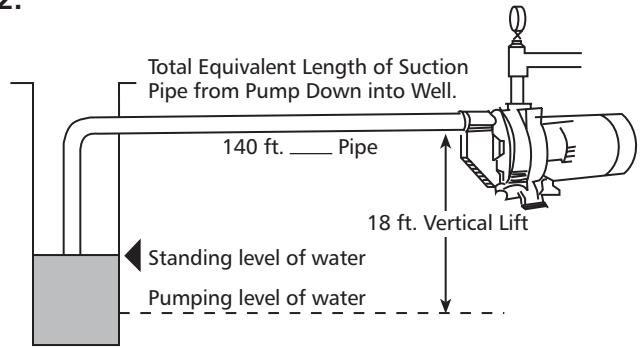

Pump Capacity 10 GPM

- a. What size suction pipe is required to keep total lift within 25 feet?

- b. What is friction loss? _____
- c. What is total lift? _____

3.

Pump Capacity 6 GPM

- Elevation: 23 ft.
- Friction Loss: 4 lbs.
- Operating Pressure: 20-40 lbs.

- a. What is the Service Pressure?

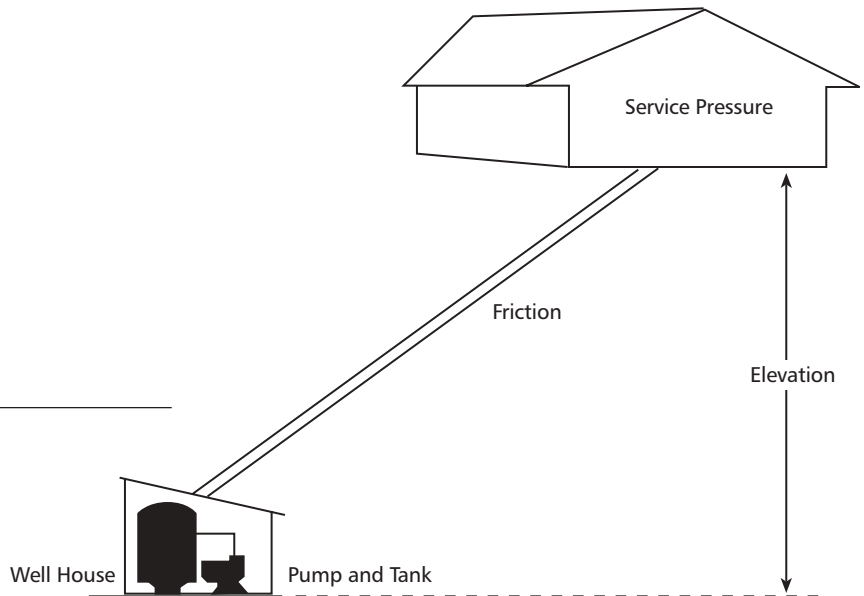

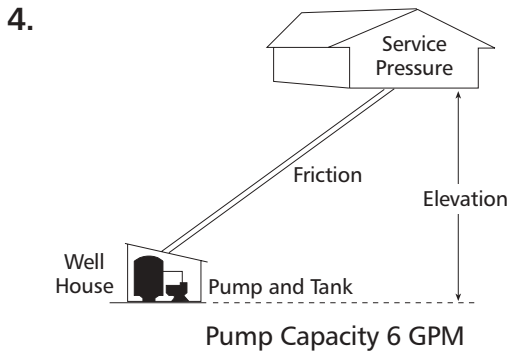

Elevation: 23 ft.
 Operating Pressure: 20-40 lbs.
 200 ft. of $\frac{3}{4}$ " Discharge Pipe

- How much is friction loss? _____
- What is the Service Pressure? _____
- What change would you make in this system and what would the result be?

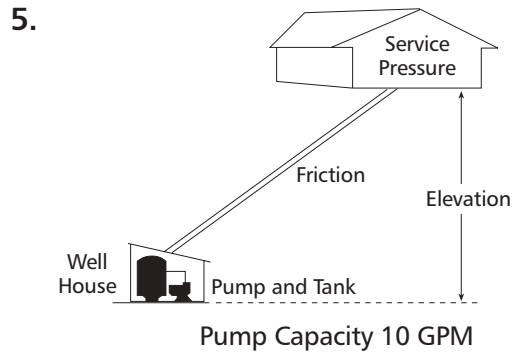

Elevation: 80 ft.
 Service Pressure Required: 20-40 lbs.
 Length of Discharge Pipe: 300 ft.

- What size pipe to use? _____
- How much is friction loss? _____
- What will the operating pressure of the pump be? _____
- How many continuous use outlets operating at the same time will this capacity supply?

Pump Capacity is 8 GPM.
 Service Pressure Required at Tank in Basement is 30 lbs.

- What is the total length of pipe to be considered for friction loss? _____ Ft.
- What is the friction loss in feet? _____ Ft.
- What is the total feet the pump will have to overcome to get water to the tank? _____ Ft.

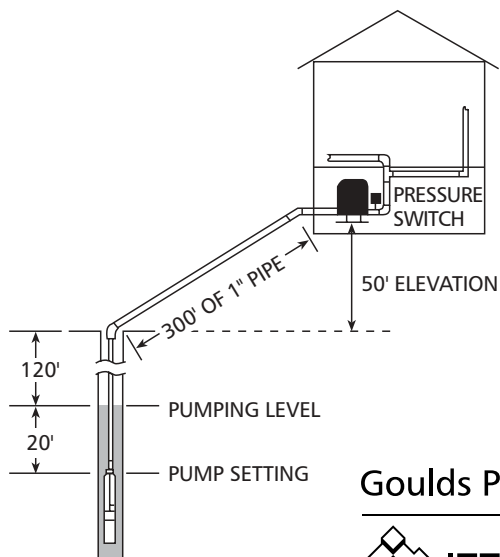

Goolds Pumps

